

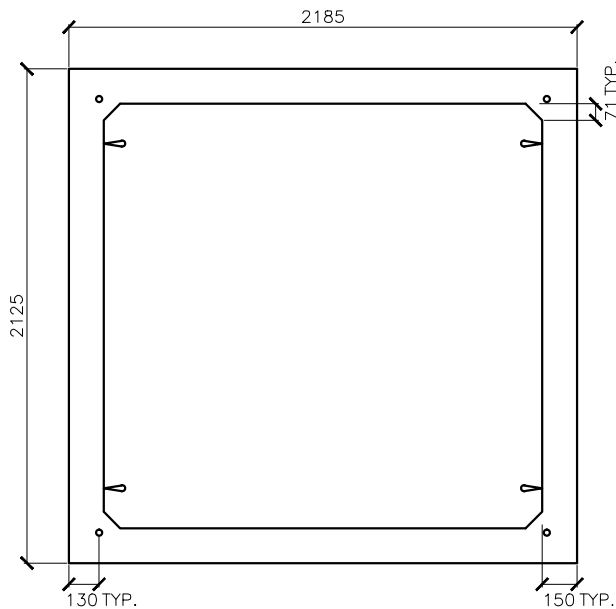

PreTech Concrete Products Ltd.

Switch Gear Base (400A, 25 kV, 3Ph) SC-2504



Conc: 32 Mpa
SR Cement

Mass: 2535 kg
5580 lbs

